

<http://www.fakro.com/download/film-installation-instructions/flashings/>

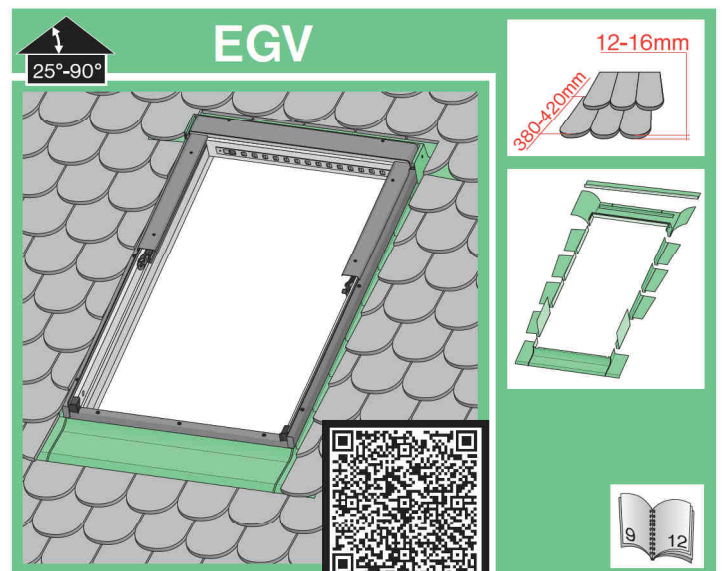

<http://www.fakro.com/download/film-installation-instructions/flashings/>

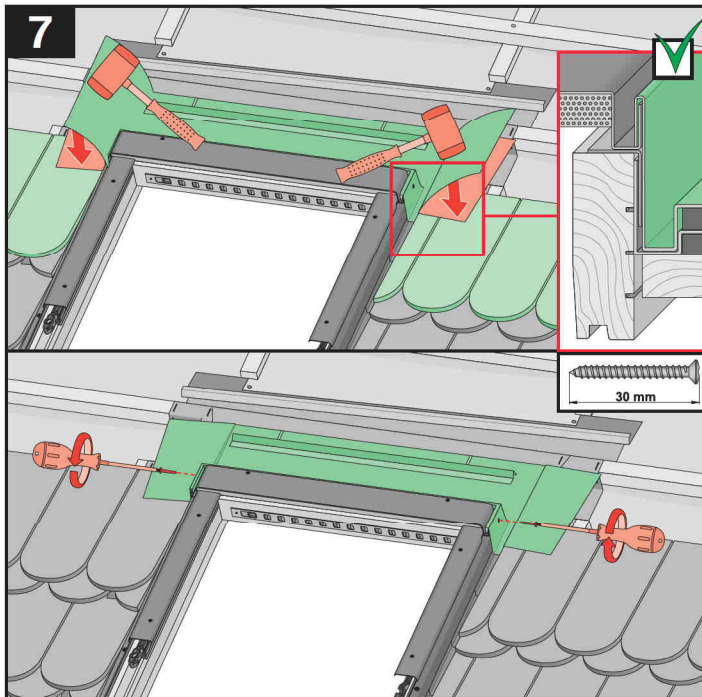
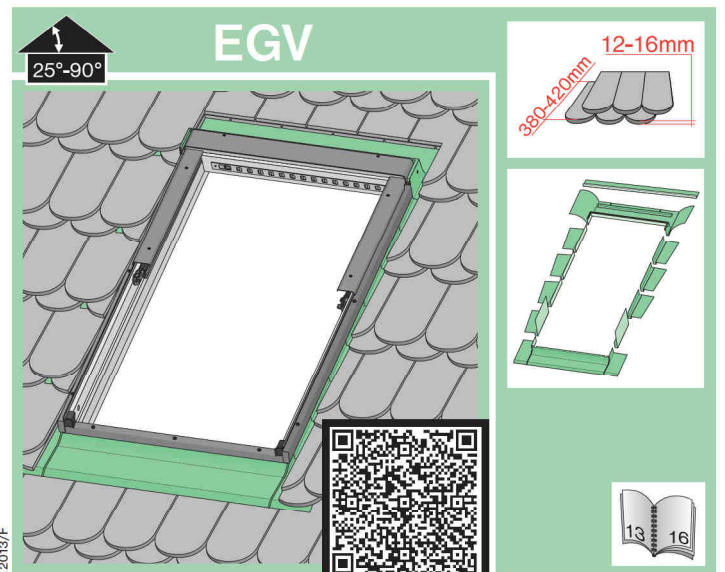
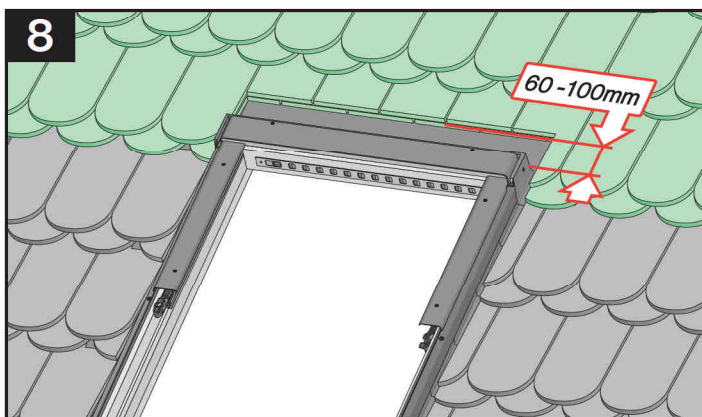

<http://www.fakro.com/download/film-installation-instructions/flashings/>

CZ Výrobce a Prodejce nenesú žádnou odpovědnost za nedodržení příslušných předpisů zákona, stavebních předpisů a bezpečnostních požadavků přes uživatele výrobku, architekta, montážní nebo majitele objektu.
DE Hersteller und Verkäufer übernehmen keine Haftung für Nichtbeachtung entsprechender Rechts- und Bauvorschriften sowie Sicherheitsanforderungen seitens Produktbenutzers, Architekten, Monteurs oder Gebäudebesitzers.
ES El fabricante y el vendedor no tienen ninguna responsabilidad por el incumplimiento de la ley vigente, normas de construcción y exigencias de seguridad por parte del usuario del producto, arquitecto, instalador o el propietario del edificio.
FR Le fabricant et le vendeur ne prend aucune responsabilité de ne pas respecter les lois applicables, les règlements sur les bâtiments et les exigences de sécurité par l'utilisateur du produit, l'architecte, l'installateur ou le propriétaire du bâtiment.
GB Manufacturer and Seller shall bear no liability for failure to comply with the applicable laws, building codes and safety requirements by the user of the product, architect, fitter or owner of the building.
HU A Gyártó és a Forgalmazó nem vállal semmilyen felelősséget a vonatkozó törvényi, építési és biztonsági előírások, termékbiztonsági, építési, beszállótermék vagy épületlátszólagos által be nem tartásáért.
IT Il Produttore e il Rivenditore non potranno essere ritenuti responsabili per il mancato rispetto da parte dell'utente del prodotto, del progettista, dell'installatore o del proprietario dell'edificio, delle leggi vigenti, nonché dei regolamenti edilizi e di quelli relativi alla sicurezza.

NL De fabrikant en verkoper zijn niet aansprakelijk voor gevolgen bij het niet opvolgen van toepasselijke wetten, bouwbesluiten en veiligheidsvoorschriften door de gebruiker van het product, de architect, de installateur of de eigenaar van het gebouw.
PL Producent i Sprzedawca nie ponoszą żadnej odpowiedzialności za niezapewnienie stosownych przepisów prawa, przepisów budowlanych i wymogów bezpieczeństwa przez użytkownika produktu, architekta, montażystę lub właściciela budynku.
PT O fabricante e o vendedor não tem nenhuma responsabilidade pelo o não cumprimento da lei, códigos de construção e as exigências de segurança por parte do usuário do produto, arquiteto, instalador ou proprietário do edifício.
RO Nu fabricantul, nu distribuitorul nu își vor asuma niciun fel de răspundere pentru nerespectarea legilor în vigoare, a legilor din domeniul construcțiilor sau a măsurilor de siguranță impuse utilizatorilor produsului, arhitecților, montajistilor sau proprietarilor clădirii.
RU Производитель и продавец несут ответственность с производителя и продавца снимается.
SK Výrobca a predajca nenesú žiadnu zodpovednosť za nedodržanie príslušných ustanovení zákona, stavebných predpisov a bezpečnostných požiadaviek užívateľom výrobku, architektom, montérmi alebo majiteľom objektu.

NC 243 IM/ELV EGV/24.06.2013/F

ELN/ELV Thermo  **ELN/ELV Isorama** 

ELJ Thermo  **ELJ Isorama** 



max 5mm (V,J)
max 15mm (N)

ELN
ELV
ELJ

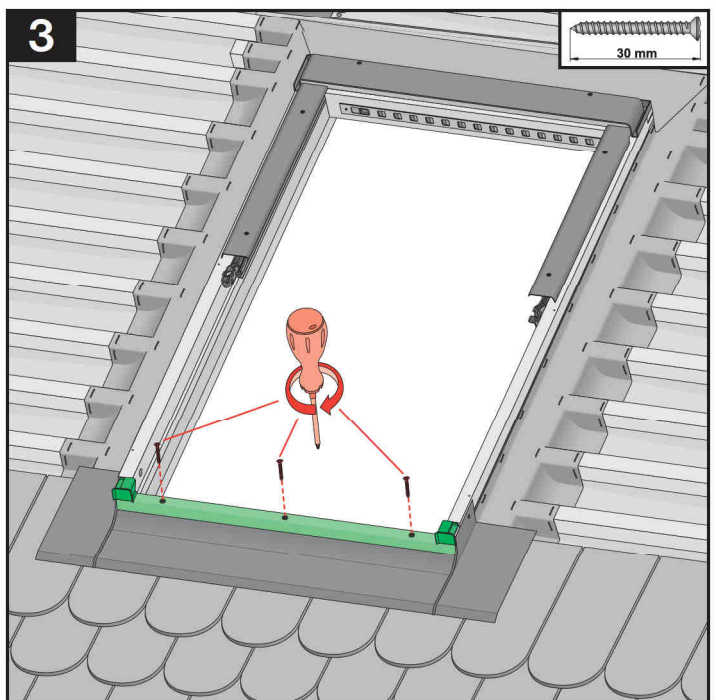
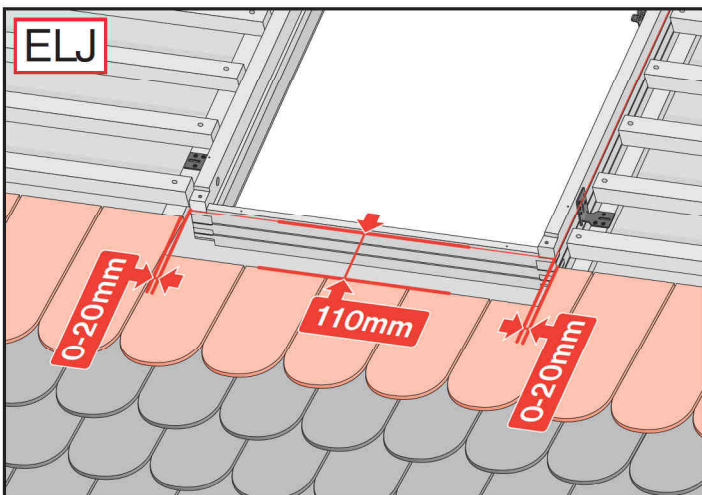
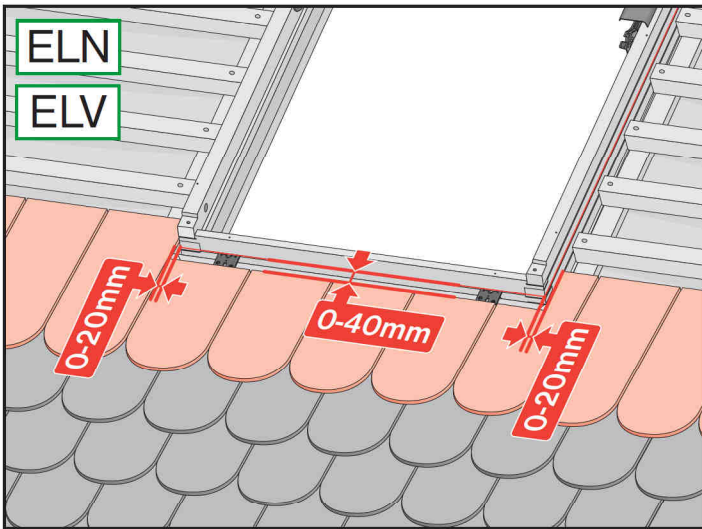
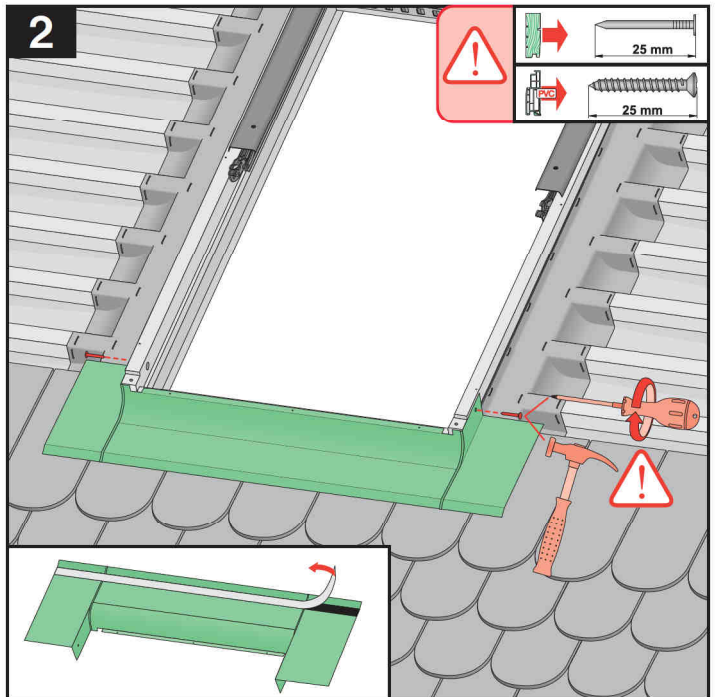
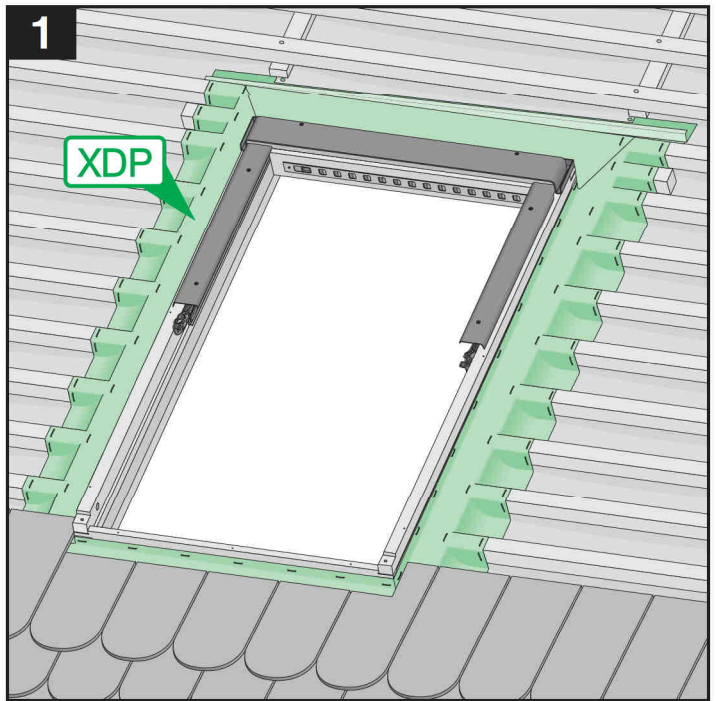
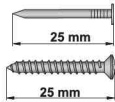
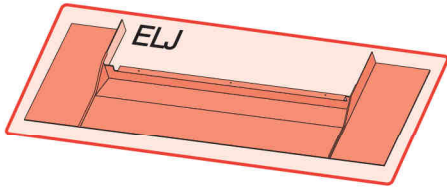
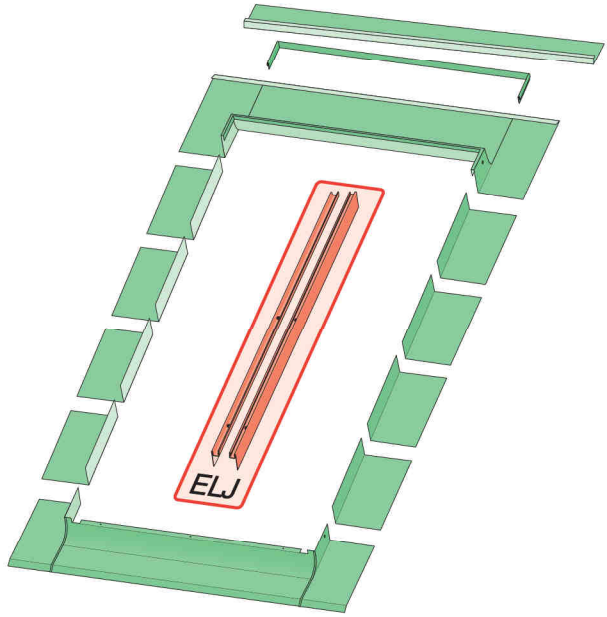

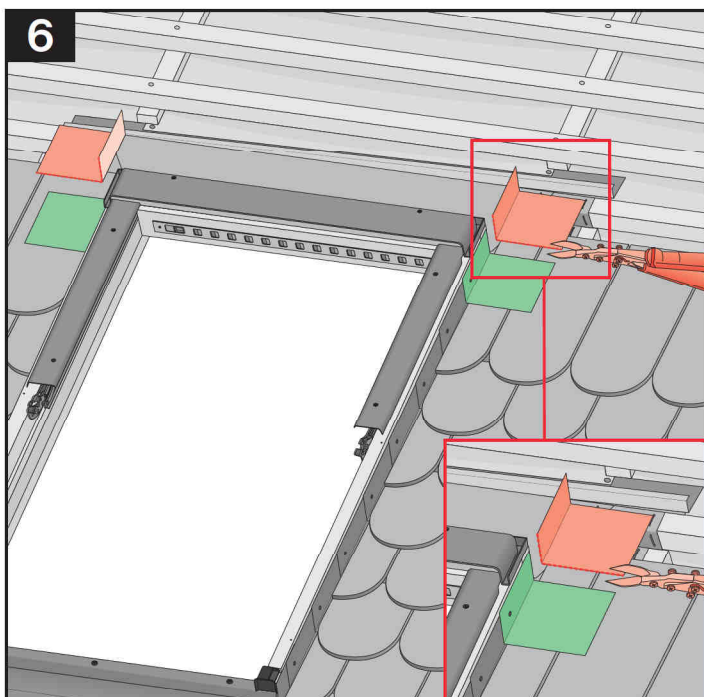
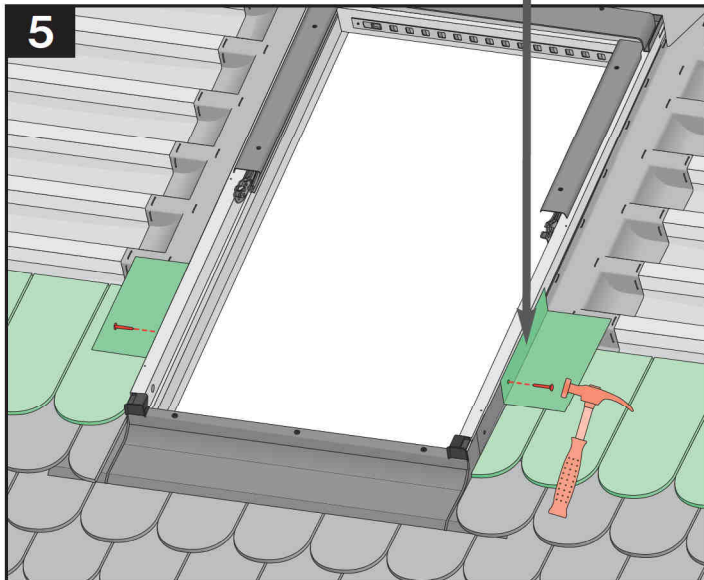
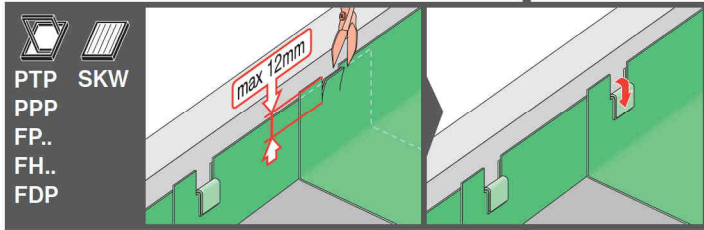
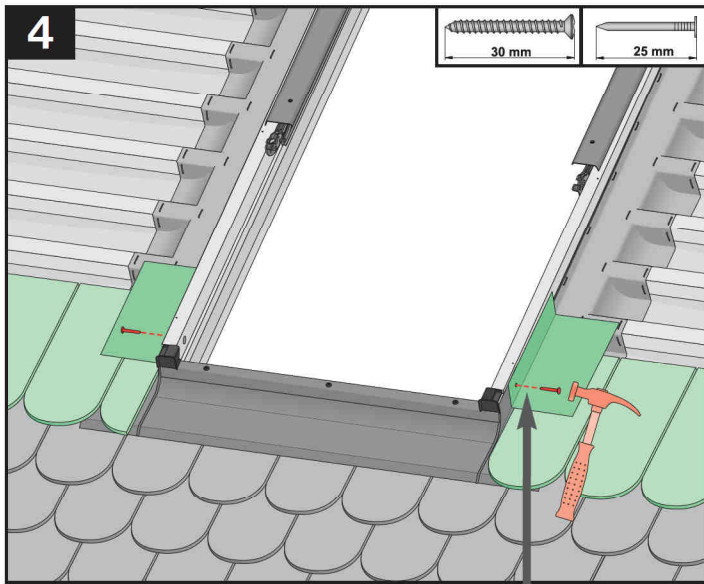

4

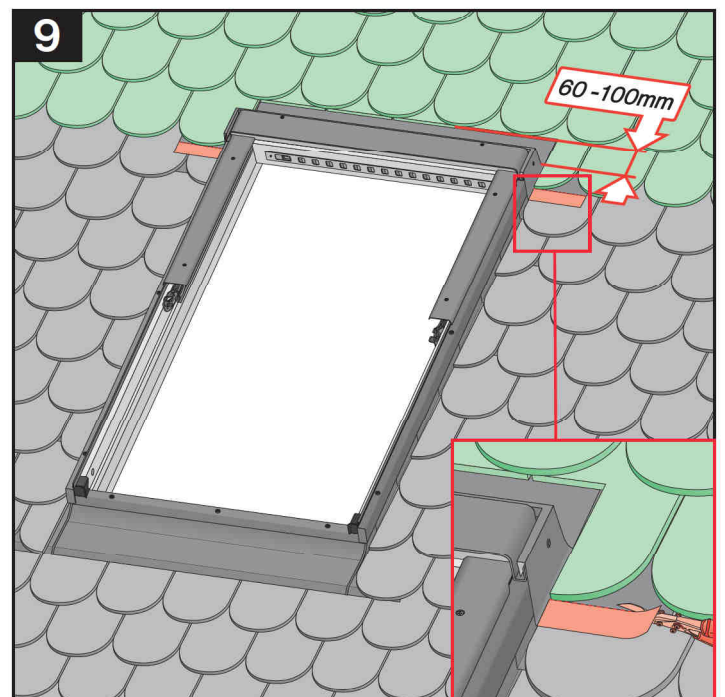
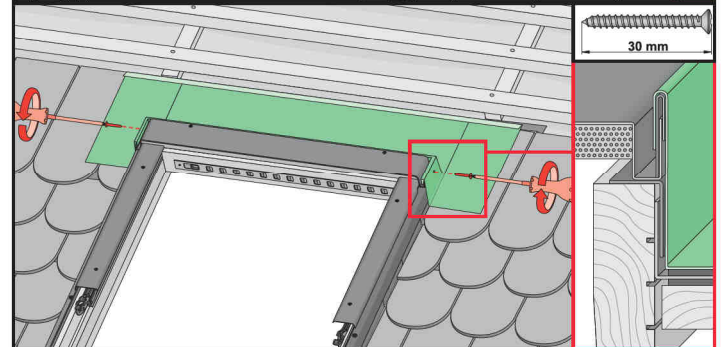
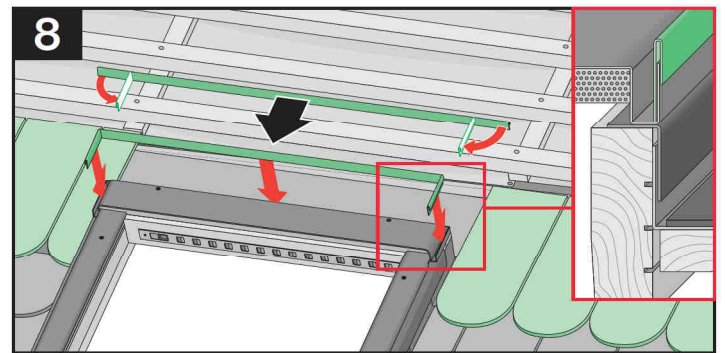
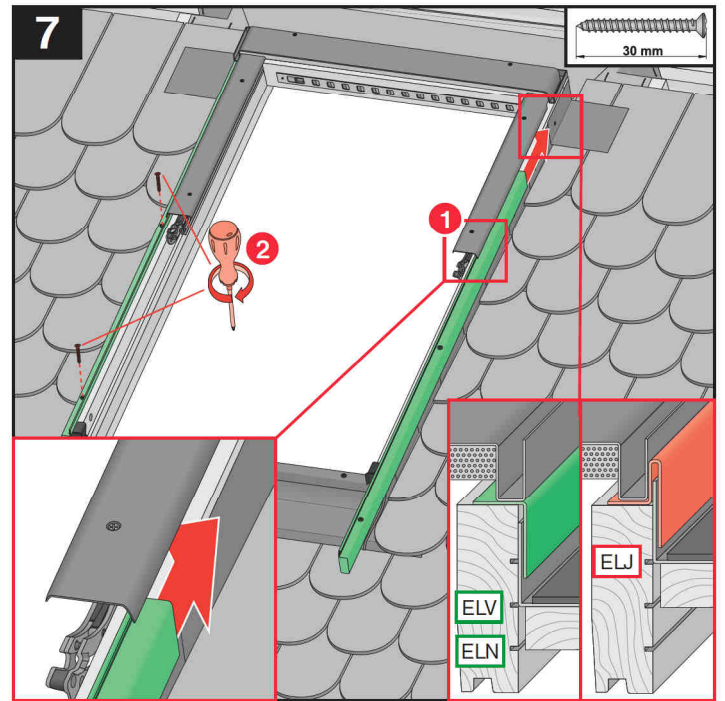

5

ELN/ELV Thermo

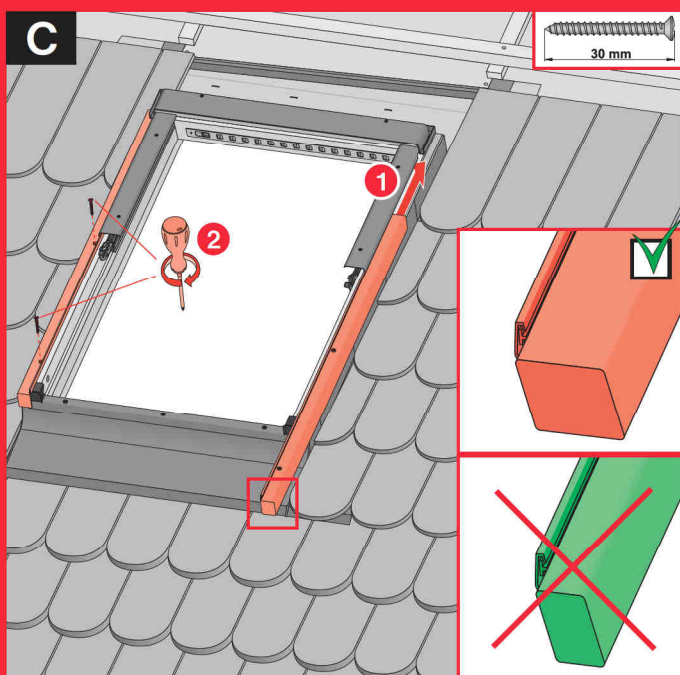
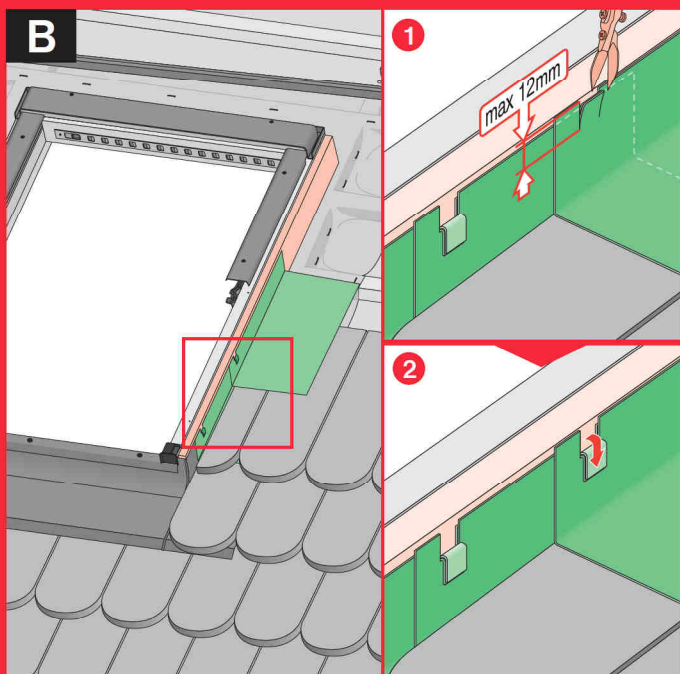
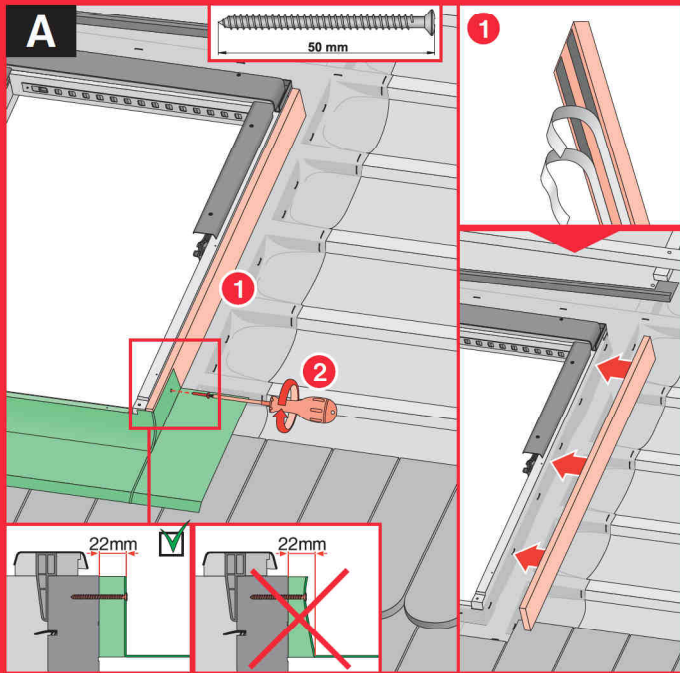

ELN/ELV Isorama

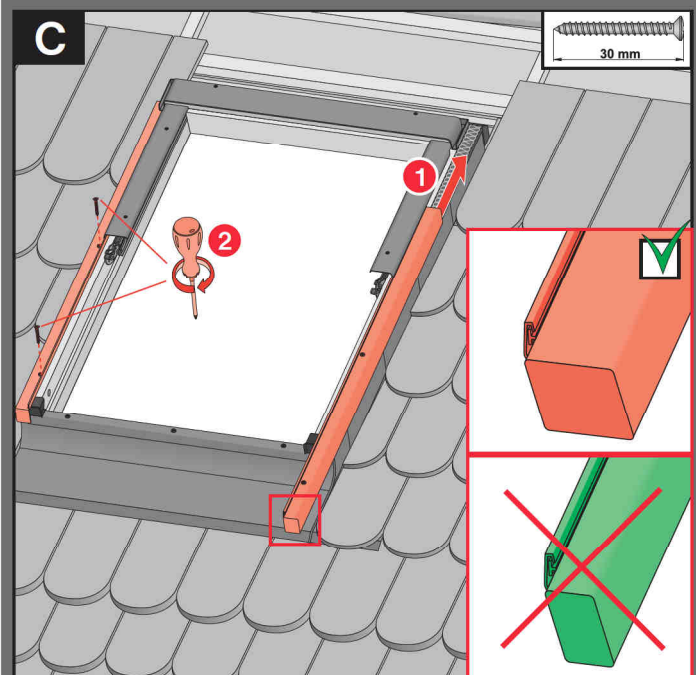
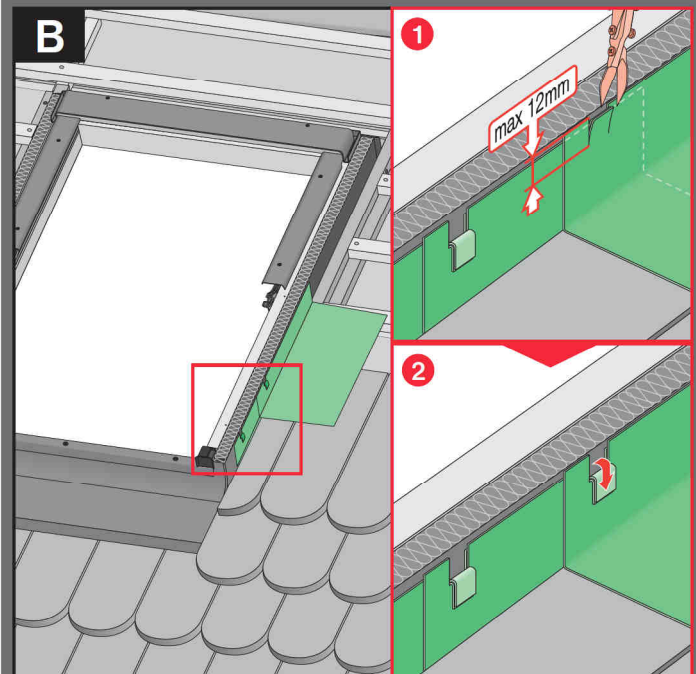
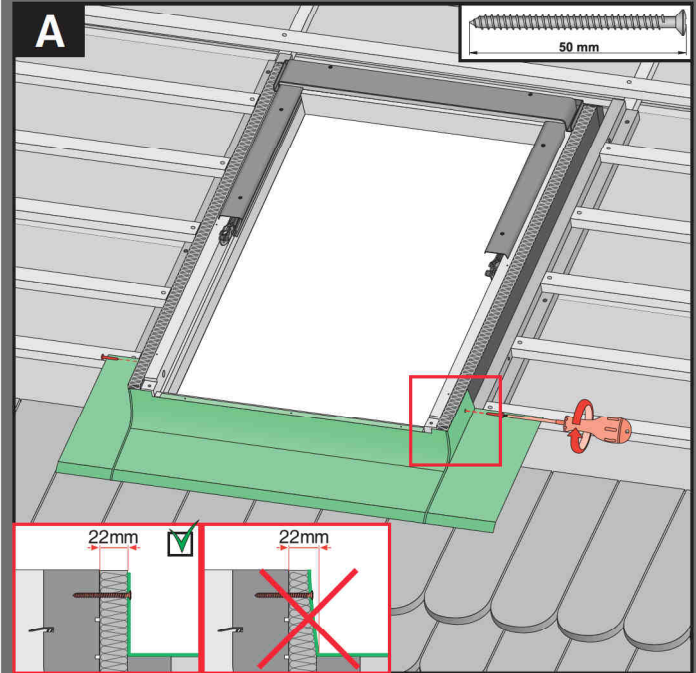

ELJ Thermo

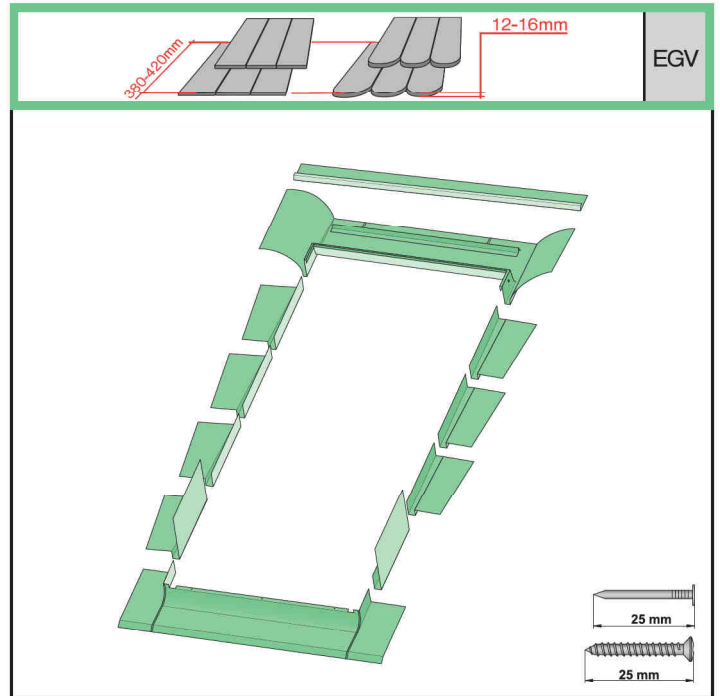
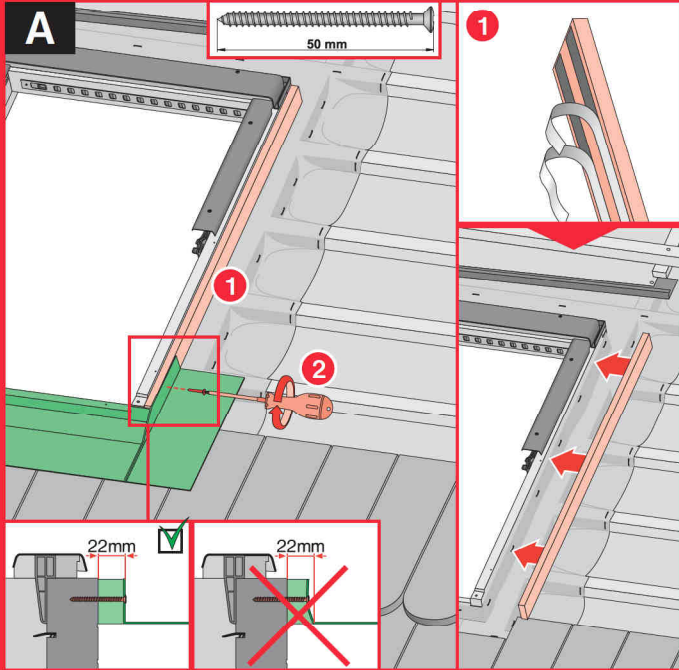

ELJ Isorama

