

COMUNELLO
MOWIN

Window
automation
technology



SMART



100% Made in Italy 

100% Made in Comunello

COMUNELLO
MOWIN

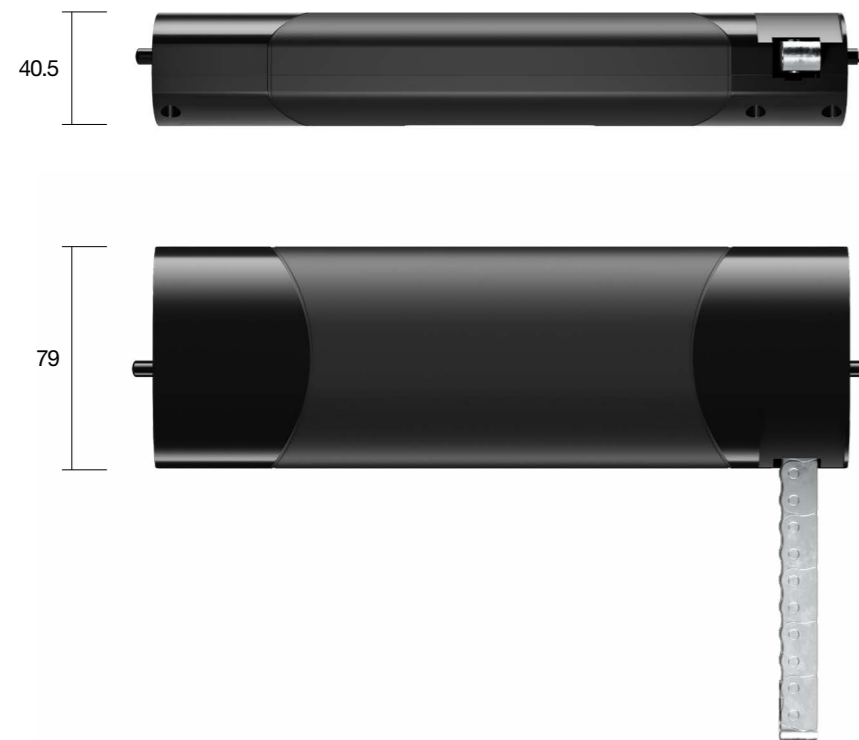
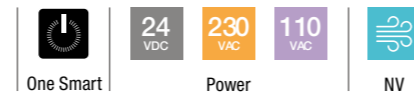

 **Vasistas**
Bottom hung



 **Sporgere**
Top hung



Caratteristiche principali

Main features

Regolabile Adjustable

2 corse facilmente regolabili tramite dip-switch, anche a motore non alimentato.

2 strokes easily adjustable via dip-switch, even when the motor is not powered.

Resistente Resistance

La catena robusta a doppia maglia e a spessore maggiorato garantisce una maggiore resistenza in spinta e in trazione.

The sturdy double-link chain with increased thickness guarantees greater resistance in push and pull.

Affidabile Reliable

Le staffe di supporto consentono l'oscillazione dell'attuatore per accompagnare il movimento della finestra.

The support brackets allow the actuator to swing to accompany the movement of the window.

Finecorsa Limit switch

Apprendimento del finecorsa in chiusura automatico per assorbimento di corrente. In questo modo è garantita una chiusura sicura e costante nel tempo.

Acquisition of the automatic closing limit switch by current absorption. In this way, a safe and constant closure over time is guaranteed.

Caratteristiche tecniche / Technical data sheet

	SMART 20 - 230 V	SMART 20 - 24 V
Forza Trazione / Traction force	250 N	250 N
Forza Spinta / Thrust force	200 N	200 N
Alimentazione / Power supply	110/230 VAC	24 VDC
Frequenza / Frequency	50/60 Hz	-
Tipo di servizio / Type of service	s2 4min	s2 4min
Velocità a vuoto / Unloaded stroke speed	16 mm/s	16 mm/s
Corse disponibili / Strokes available	180 - 380	180 - 380
Temperatura di funzionamento / Operating temperature	-5°C + 50°C	-5°C + 50°C
Grado di protezione IP / IP protection class	20	20
Soft START / Soft STOP	Sì / Yes	Sì / Yes
Assorbimento corrente / Current draw	0,14 A	0,9 A
Potenza assorbita / Power draw	22 W	22 W
Rilevamento ostacolo / Obstacle detection	Sì / Yes	Sì / Yes
Collegamento in parallelo / Connection in parallel	Max 30 Attuatori Max 30 actuators	Max 30 Attuatori Max 30 actuators
Sincronizzazione / Synchronisation	No	No
Dimensioni / Dimensions	41 X 79 X 265 mm	41 X 79 X 265 mm
Finecorsa in apertura / Open limit switch	Sensore / Sensor	Sensore / Sensor
Finecorsa in chiusura / Closed limit switch	Amperometrica / Amperometric	Amperometrica / Amperometric
Peso attuatore / Actuator weight	1,10 Kg	1,10 Kg

Installazione Installation

Installazione facile e veloce grazie all'aggancio rapido delle staffe.

Quick and easy installation thanks to the quick coupling of the brackets.

Completo Complete

L'attuatore SMART è completo di staffe ed attacchi catena sia per applicazioni a vasistas che a sporgere.

The SMART actuator is complete with brackets and chain attachments for both bottom-hung and top-hung applications.

Kit smart twin

È disponibile il KIT SMART TWIN composto da 2 attuatori ed interfaccia AF-960 da installare in un'unica finestra.

The SMART TWIN KIT is available, consisting of 2 actuators and AF-960 interface to be installed in a single window.

Smart

Configurazione dell'attuatore Actuator configuration



Sporgere Top hung

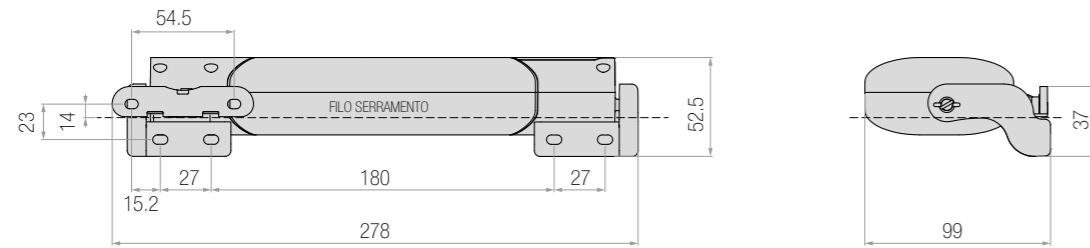

Vasistas Bottom hung

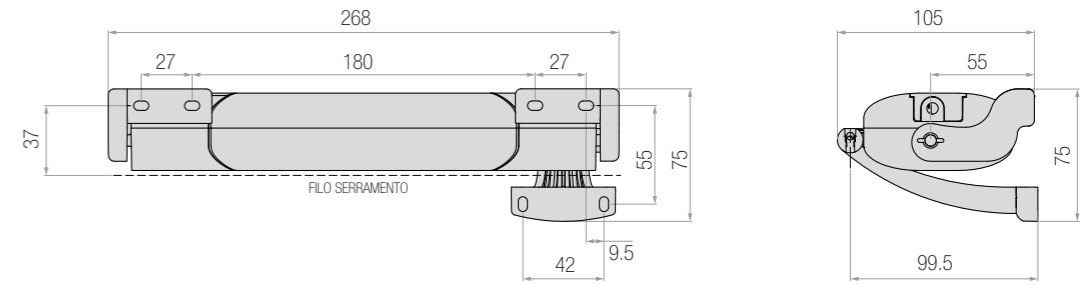

SMART - Angolo di apertura anta a sporgere SMART - Top hung opening angle

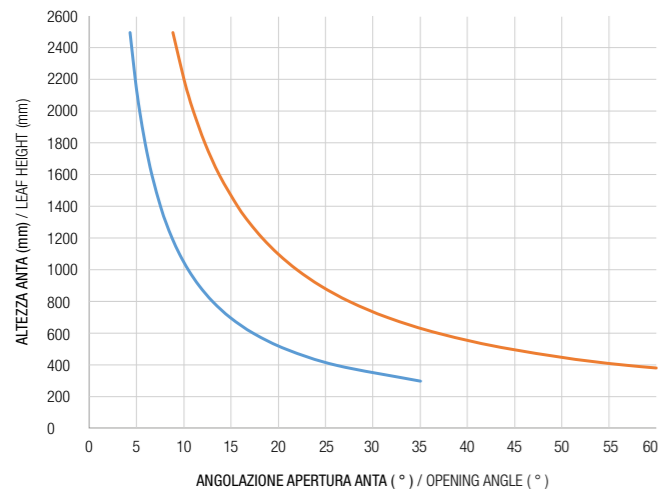

SMART - Portate attuatori a sporgere SMART - Actuator force - top hung

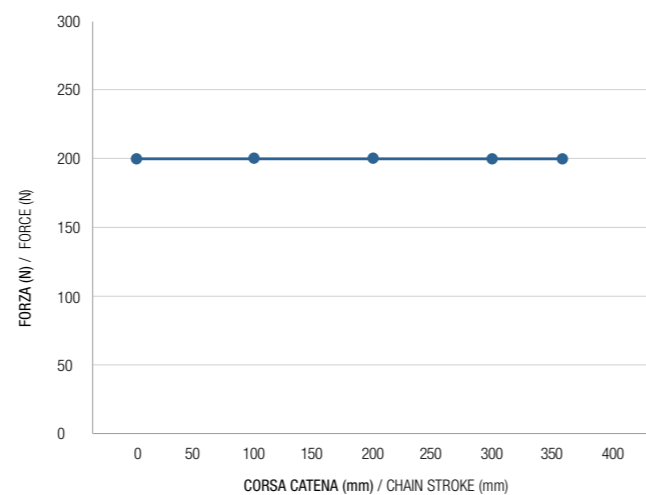

CORSA / STROKE — 180 mm — 380 mm

I valori indicati nei grafici sono da considerarsi indicativi e non considerano eventuali deformazioni dovute a fattori esterni.
The values indicated in the graphs are to be considered indicative and do not consider any deformations due to external factors.

● SPORGERE / TOP HUNG OUTWARD OPENING ABBAINO / DORMER

Per scegliere l'attuatore Comunello Mowin più adatto, è necessario calcolare la FORZA (F) necessaria a sostenere il movimento della finestra. Il tipo di attuatore va selezionato considerando la combinazione tra la dimensione di BASE del serramento e la forza calcolata (N).

In order to choose the most suitable Comunello Mowin actuator, you have to calculate the necessary FORCE (F) to sustain the window movement. Choose the actuator type in accordance with the CALCULATED FORCE (N) and the FRAME DIMENSION.

SMART - Angolo di apertura anta vasistas SMART - Bottom hung opening angle

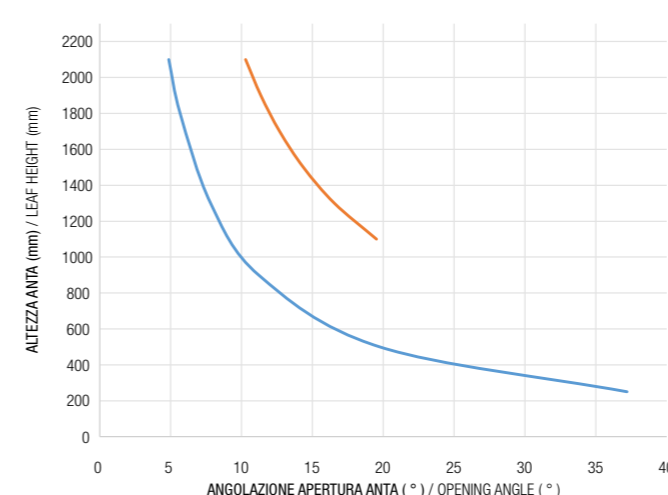

SMART - Portate attuatori vasistas SMART - Actuator force - bottom hung

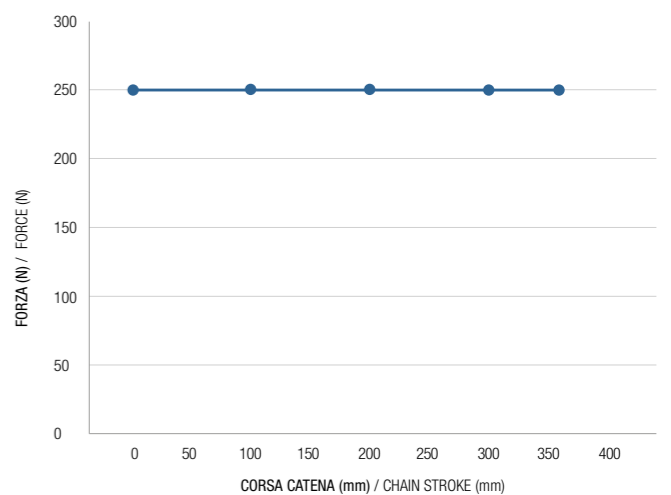

CORSA / STROKE — 180 mm — 380 mm

● VASISTAS / BOTTOM HUNG INWARD OPENING

I valori indicati nei grafici sono da considerarsi indicativi e non considerano eventuali deformazioni dovute a fattori esterni.
The values indicated in the graphs are to be considered indicative and do not consider any deformations due to external factors.

Formule per il calcolo della forza necessaria a movimentare il serramento Formulas for calculating the force necessary to move the window

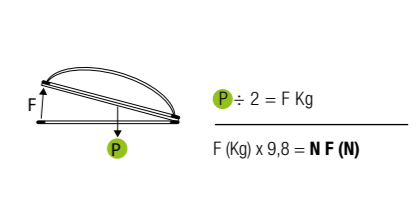
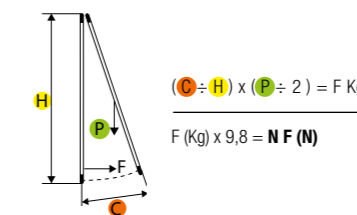
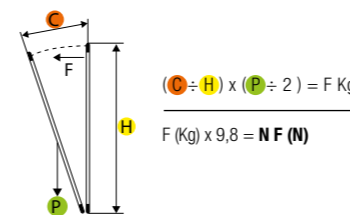

F = Forza necessaria
Necessary Force (Kg)

C = Corsa di apertura
Opening stroke (mm)

H = Altezza serramento
Window height (mm)

P = Peso serramento
Window weight (Kg)

Smart

Article	Product code	Push / pull	Strokes	Colour	Power supply	Power	Weight	Pcs
SMART 20 230Vac	MSMART20HOB00	200/250 N	180 - 380 mm	NERO / Black	230 VAC	22W	0,78 kg	1
SMART 20 230Vac	MSMART20HOG00	200/250 N	180 - 380 mm	GRIGIO / Grey	230 VAC	22W	0,78 kg	1
SMART 20 230Vac	MSMART20HOW00	200/250 N	180 - 380 mm	BIANCO / White	230 VAC	22W	0,78 kg	1
SMART 20 110Vac	MSMART20IOB00	200/250 N	180 - 380 mm	NERO / Black	110 VAC	22W	0,78 kg	1
SMART 20 110Vac	MSMART20IOG00	200/250 N	180 - 380 mm	GRIGIO / Grey	110 VAC	22W	0,78 kg	1
SMART 20 110Vac	MSMART20IOW00	200/250 N	180 - 380 mm	BIANCO / White	110 VAC	22W	0,78 kg	1
SMART 20 24Vdc	MSMART20LOB00	200/250 N	180 - 380 mm	NERO / Black	24 VDC	22W	0,78 kg	1
SMART 20 24Vdc	MSMART20LOG00	200/250 N	180 - 380 mm	GRIGIO / Grey	24 VDC	22W	0,78 kg	1
SMART 20 24Vdc	MSMART20LOW00	200/250 N	180 - 380 mm	BIANCO / White	24 VDC	22W	0,78 kg	1

La confezione contiene:	Box contains:
 <p>Attuatore Actuator</p> 	<p>Staffe Vasistas Vasistas brackets</p> 
<p>Staffe Sporgere Sporgere brackets</p> 	<p>Staffe di supporto Support brackets</p> 
<p>Dima per l'installazione Mounting template</p> 	<p>Manuale d'uso User manual</p> 

Kit Smart Twin



Kit per l'installazione di 2 attuatori
SMART 230VAC sullo stesso infisso



Article	Product code	Push / pull	Strokes	Colour	Power supply	Power	Weight	Pcs
SMART TWIN 230Vac	MKSMART20HOB01	200/250 N	180 - 380 mm	NERO / Black	230VAC	22W	2,50 kg	1
SMART TWIN 230Vac	MKSMART20HOG01	200/250 N	180 - 380 mm	GRIGIO / Grey	230VAC	22W	2,50 kg	1
SMART TWIN 230Vac	MKSMART20HOW01	200/250 N	180 - 380 mm	BIANCO / White	230VAC	22W	2,50 kg	1





COMUNELLO GROUP

INNOVATING TOGETHER